

### ⚡ Specifications

#### Nominal Voltage(V)

12V

#### Nominal Power

15 mins rate: 135W/cell to 1.67V/cell

#### Nominal Capacity

20 hour rate	(1.8A to 10.50V)	36Ah
8 hour rate	(3.87A to 10.50V)	31Ah
5 hour rate	(6.12A to 10.20V)	30.6Ah

#### Weight

Approx. 11.0kg(24.2Lbs.)

#### Internal Resistance (at 1KHz)

Approx. 8 mΩ

#### Maximum Discharge Current for

5 seconds: 540A

#### Short Circuit Current (A) IEC 60896-21-22

1800 A

#### Charging Methods at 25°C(77°F)

Maximum Charging Current :	10.8A
Boost Charging Voltage	14.4 to 15.0V
Boost Charge Time	8-9Hr
Float Charging Voltage	13.5 to 13.8V
Coefficient	-3.0mV/°C/cell

#### Operating Temperature Range

Charge	-15°C(5°F)	to	40°C(104°F)
Discharge	-15°C(5°F)	to	50°C(122°F)
Storage	-15°C(5°F)	to	40°C(104°F)

#### Charge Retention (shelf life) at 20°C(68°F)

1 month	98%
3 month	96%
6 month	94%

#### Case Material

ABS UL94 HB  
Option: Flammability resistance of (UL94 V-0)

#### Battery Construction

Component	Positive Plate	Negative plate	Safety valve	Terminal	Separator	Electrolyte
Raw material	Lead dioxide	Lead	Rubber	Lead	AGM	Sulfuric acid



### ⚡ Dimensions

#### Length (L)

197 ±<sub>1</sub><sup>2</sup> (7.76 ±<sub>0.04</sub><sup>0.08</sup>)

#### Width (W)

131 ±<sub>1</sub><sup>2</sup> (5.16 ±<sub>0.04</sub><sup>0.08</sup>)

#### Height (H)

159 ±<sub>1</sub><sup>2</sup> (6.26 ±<sub>0.04</sub><sup>0.08</sup>)

#### Overall Height (HT)

180 ±<sub>1</sub><sup>2</sup> (7.09 ±<sub>0.04</sub><sup>0.08</sup>)

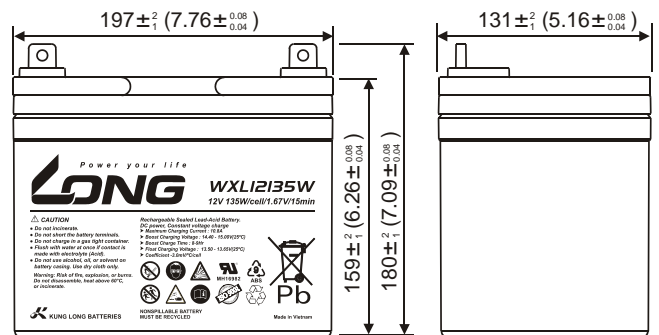
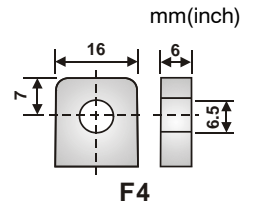
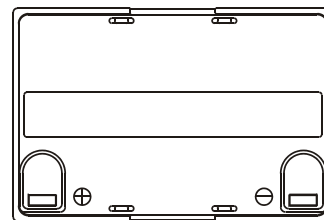

#### Terminal

F4

#### Design Life

Expected Trickle Design Life: 6-9 years at 20°C according to Eurobat.

Effect of Temperature on Capacity 25°C(77°F)

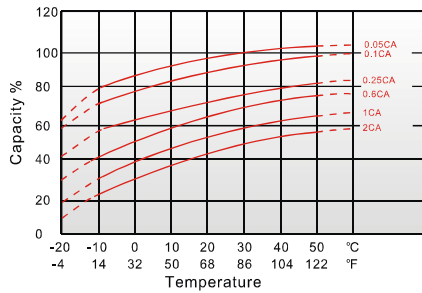

Capacity Retention Characteristic

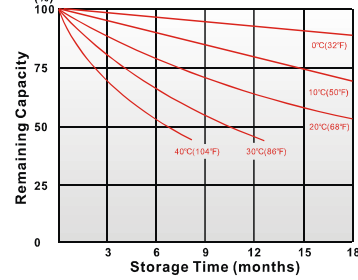

Discharge Time VS. Discharge Current (25°C)

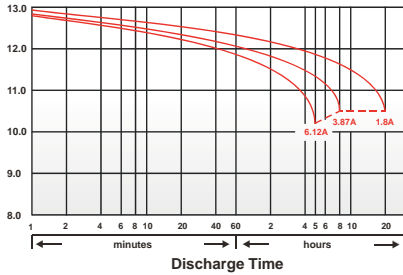

Trickle (or float) Service Life

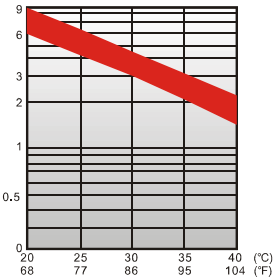

### - PERFORMANCE DATA

#### Discharge Rates in Watts to Various End Voltages at 25°C(77°F)

End Voltage		1.85V	1.80V	1.75V	1.70V	1.67V	1.65V	1.63V	1.60V
2	min	271	304	321	336	348	354	356	358
4	min	212	243	260	274	280	285	289	292
5	min	209	226	245	258	265	270	274	277
6	min	205	225	240	247	252	256	259	262
8	min	168	180	190	198	212	216	219	222
10	min	144	157	165	168	171	174	177	179
15	min	125	128	131	133	135	137	138	139
20	min	103	107	109	111	113	115	116	117
30	min	76.5	78.3	79.3	79.9	80.3	80.7	81.1	81.4
45	min	57.2	57.9	58.5	58.8	59.1	59.2	59.3	59.3
60	min	43.7	45.0	45.8	46.3	46.6	46.7	46.8	46.9
90	min	33.0	33.7	34.1	34.5	34.8	35.0	35.2	35.3
120	min	22.4	23.6	24.3	24.7	24.9	25.1	25.3	25.3
180	min	15.1	15.7	16.2	16.6	16.9	17.1	17.2	17.3
240	min	11.2	11.7	11.9	12.1	12.3	12.4	12.5	12.5
300	min	9.53	9.89	10.0	10.1	10.2	10.2	10.3	10.4
600	min	4.83	5.00	5.13	5.22	5.28	5.31	5.34	5.37
1200	min	3.22	3.32	3.42	3.44	3.48	3.50	3.52	3.54

#### - Discharge Rates in Amperes to Various End Voltages at 25°C(77°F)

End Voltage		1.85V	1.80V	1.75V	1.70V	1.67V	1.65V	1.63V	1.60V
2	min	157	171	183	193	203	208	212	217
4	min	130	146	158	166	169	170	171	172
5	min	115	128	134	136	139	140	141	142
6	min	98.2	104	107	109	111	112	113	114
8	min	90.2	96.1	99.2	101	103	105	107	109
10	min	83.2	88.6	91.6	93.7	95.7	97.3	98.3	98.8
15	min	64.2	67.2	71.0	73.8	75.0	75.3	75.6	75.8
20	min	53.2	56.0	58.3	59.0	59.5	59.7	59.9	60.0
30	min	35.9	38.1	39.9	40.3	40.5	40.8	41.0	41.1
45	min	26.8	29.3	31.0	31.3	31.8	32.1	32.3	32.4
60	min	20.0	21.0	21.6	21.9	22.1	22.3	22.4	22.5
90	min	16.3	17.0	17.5	17.7	17.9	18.1	18.2	18.2
120	min	11.8	12.4	12.8	13.0	13.1	13.2	13.3	13.3
180	min	8.38	8.73	9.00	9.22	9.38	9.50	9.58	9.62
240	min	6.78	7.07	7.21	7.30	7.36	7.38	7.39	7.40
300	min	5.69	5.93	6.02	6.06	6.10	6.12	6.14	6.16
600	min	3.22	3.33	3.42	3.48	3.52	3.54	3.55	3.55
1200	min	1.71	1.76	1.80	1.82	1.84	1.84	1.85	1.85

All data on the spec. sheet is an average value:

The tolerance range :  $X < 6\text{min}$ (+15%~-15%),  $6\text{min} \leq X < 10\text{min}$ (+12%~-12%),  $10\text{min} \leq X < 60\text{min}$ (+8%~-8%),  $X \geq 60\text{min}$ (+5%~-5%)

310323-1H